

artesia

DP-3 +



Owner's Manual

Virgin Musical Instruments

Precaution

Thank you for purchasing this digital instrument. For perfect operation and security, please read the manual carefully and keep it for future reference.

Safety Precautions



The lightning with arrowhead symbol within an equilateral triangle is intended to alert the user to the risk of electrical shock within the product's enclosure that may cause injury.



The exclamation point within an equilateral triangle is intended to alert the user to follow the operating and maintenance instructions found in the literature accompanying the product.

Important Safety Instructions

- 1) Read and follow these instructions.
- 2) Keep these instructions.
- 3) Heed all warnings.
- 4) Do not use this product near water.
- 5) Clean only with a dry cloth.
- 6) Do not block any ventilation openings; install in accordance with the manufacturer's instructions.
- 7) Do not install near any heat sources such as radiators, heat registers, stoves, or any other apparatus (including amplifiers) that produce heat.
- 8) Only power this product using a grounded electrical outlet.
- 9) Protect the power cord from being walked on or pinched particularly at plugs, convenience receptacles, and the point where they exit from the apparatus.
- 10) Only use official attachments/accessories specified by the manufacturer.
- 11) Use only with the cart, stand, tripod, bracket, or table specified by the manufacturer, or sold with the apparatus. When a cart is used, use caution when moving the cart/apparatus combination to avoid injury from tip-over (Figure 1).
- 12) Unplug this apparatus during lightning storms or when unused for a long periods of time.
- 13) Refer all servicing to qualified service personnel. Servicing is required when the apparatus has been damaged in any way, such as power-supply cord or plug is damaged, liquid has been spilled or objects have fallen into the apparatus, the apparatus has been exposed to rain or moisture, does not operate normally, or has been dropped.



(Figure 1)

WARNING: To reduce the risk of fire and electric shock do not expose this apparatus to rain or moisture.

WARNING: This product contains chemicals, including lead, known to the State of California to cause cancer, and/or birth defects or other reproductive harm. Wash hands after handling.

Thank you for choosing the Artesia DP-3 Digital Piano

Your new piano is a high quality digital piano featuring an 88 note hammer action and touch sensitive keyboard. Plus the most advanced 3D sampling tone generation technology that together will provide you with a rich performing and playing experience. You can also record your own performances or record your own accompaniment to play along with. Your Artesia DP-3 is not only an excellent piano but is also a traditional piece of furniture that will look great in any home décor. To get the most out of your instrument, please read this manual and try out the various functions as you go. Additionally there are so many different exciting features and functions you can also access by plugging in your laptop, table or smartphone. Your new instrument contains the latest technology and is built to last and should continue to offer musical enjoyment of many years to come.

If you have any questions or comments regarding your new piano please call or email us, we would love to hear from you:

TOLL FREE PHONE 888-998-9848
EMAIL info@virginmusicalinstruments.com

Thank you for your Support:
Virgin Musical Instrument Company Inc
PO Box 2908
La Mesa, CA 91943

Contents

Panel Control	1
Setup	3
Basic Operation	4
Standby/On	4
AutoStandby	4
Deactivate Auto standby Function	4
Adjusting Volume & Start Playing	4
Piano Pedals	4
Playing Demo Songs	5
[+ / YES] & [- / NO]	6
The Connector Box	7
Headphones	7
MIDI Out	7
Line Out	8
Using USB MIDI/USB Audio	8
Aux In	8
Voice/Effect	9
Selecting a Voice	9
Layer Button	9
Split Button	10
Reverb	10
Chorus	11
Duet	11
Metronome	12
Touch	12
Set Up	14
Song Recording	21
Start recording	21
Stop recording	21
Listen to your recording	21
Track Clear.....	22
Learning Function	23
Selecting a song	23
Listening to the entire song.....	23
Practicing the right hand of the selected song	24
Practicing the left hand of the selected song	24
Turn Off the Learning Function	24
MIDI Function	25
Local On/Off	25
Appendix	26
MIDI Implementation Chart	26
Voice List	27
Factory Reset	28
Specifications	29
Assembly Instructions.....	30

Panel Control

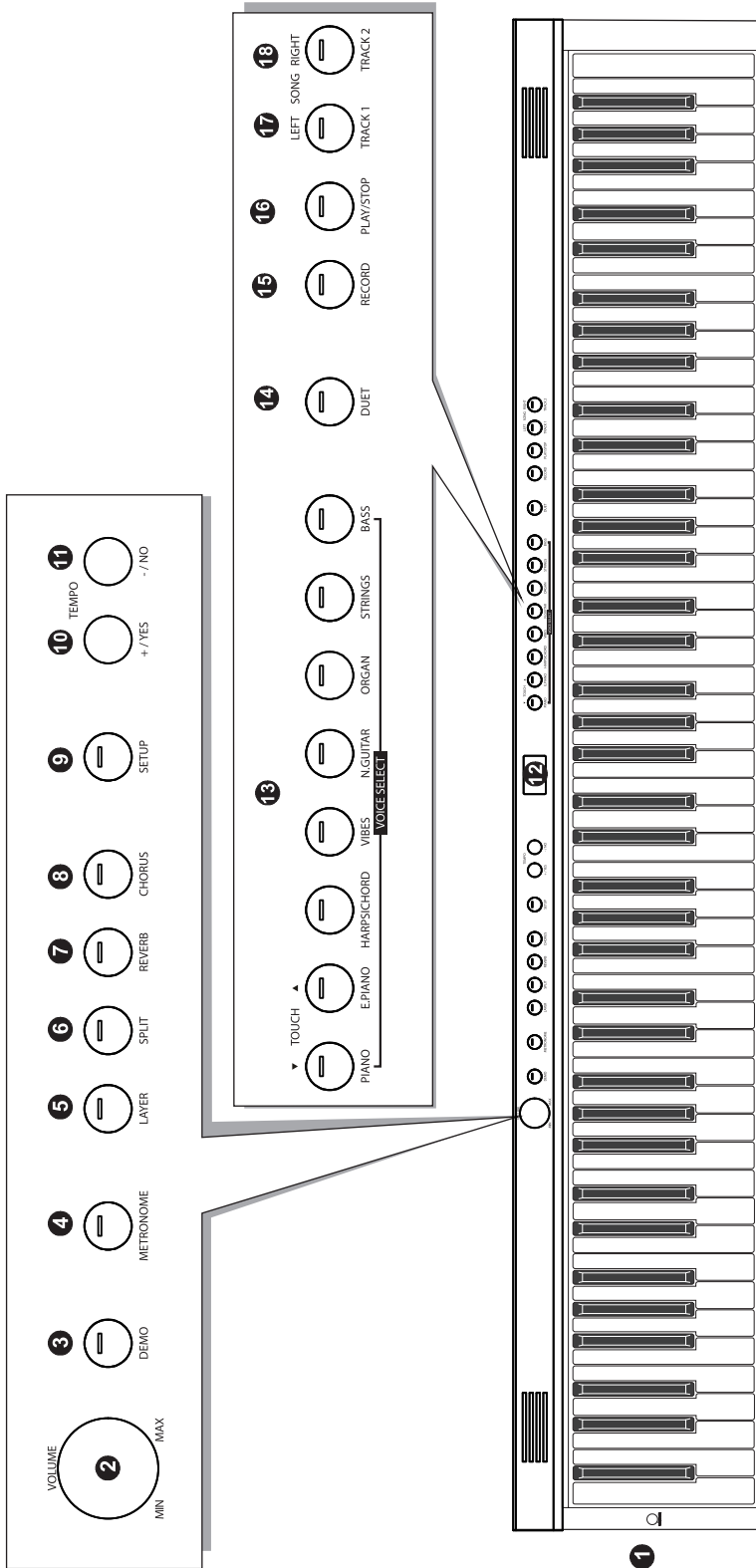

Rear Panel

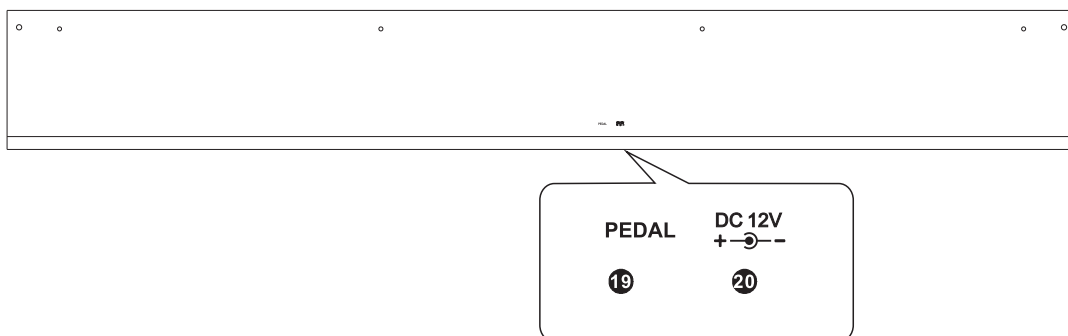

Connections Panel

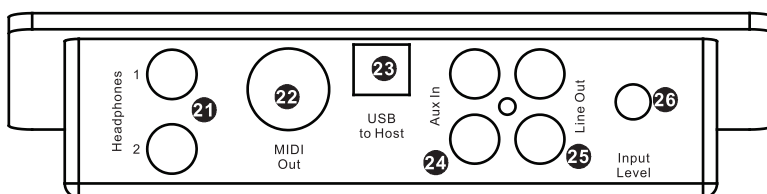

Front Panel

1. STANDBY /ON button
2. VOLUME Data Control knob
3. DEMO button
4. METRONOME button
5. LAYER button
6. SPLIT button
7. REVERB button
8. CHORUS button
9. SETUP button
10. +/YES button
11. -/NO button
12. LDC display
13. Voice Select buttons
14. DUET button
15. RECORD button

16. PLAY/STOP button
17. LEFT/TRACK 1 button
18. RIGHT/TRACK 2 button

Rear Panel

19. Pedal Connector
20. Power Connector (DC 12V)

Connections Panel

21. Headphones 1 / 2
22. MIDI Out
23. USB to Host Connector
24. Aux Line In
25. Line Out
26. Aux Input Level

Setup

You are no doubt eager to play your new piano instrument, but first please make sure you have completed the following setup steps:

- 1) Follow the assembly instructions as outlined on page 30.
- 2) Once the piano is securely assembled, connect the plug of the foot pedal unit into the pedal jack located on the rear panel.

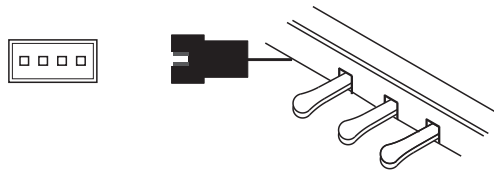

- 3) Plug the other end of the power cable into the power outlet.

NOTE

1. Ensure the piano is turned off before connecting and disconnecting the power.
2. Turn the volume knob to its minimum level before turning on the power.

Basic Operation

Standby/On

Press the [STANDBY/ON] button to turn on the power and the LCD display will illuminate.



Auto Standby

Your piano will switch off automatically after 30 minutes of inactivity. In this case, press the [STANDBY/ON] button to turn on the power.

Deactivate Auto Standby Function

To deactivate the Auto Standby Function: hold the first white key and first black key from the left side of the keyboard at the same time and then press the [STANDBY/ON] button.

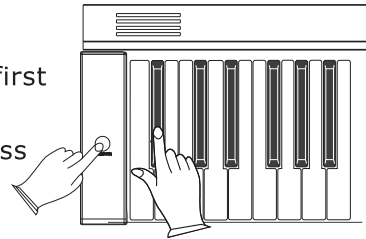

Adjusting Volume & Start Playing

The speaker system in your piano is very powerful and can be overpowering in some rooms. Adjust the [VOLUME] control to a 12 o'clock position as a safe starting point. You can adjust the volume at any time even while you are playing.

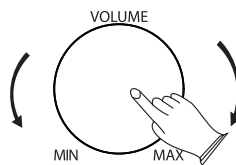

Now play the keyboard. You should hear the rich tone of the default Grand Piano sound.

Piano Pedals

Just like a regular grand piano, your piano features 3 foot pedals:

Damper Pedal (Right)

The damper pedal performs the same function as the damper pedal on an actual acoustic piano, letting you sustain the sound of the notes being played after releasing your fingers from the keys.

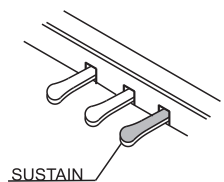

Sostenuto Pedal (Center)

The sostenuto pedal also allows you to sustain notes, but it works a little different than the damper pedal. If you play a note or chord on the keyboard and press the sostenuto pedal while the notes are held, those notes will be sustained as long as the pedal is held. All subsequently played notes will not be sustained.

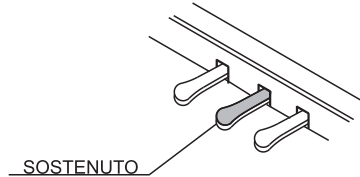

Soft Pedal (Left)

The soft pedal on an acoustic piano changes the character of the sound, making it softer and quieter. The soft pedal on your piano does exactly the same. Press the soft pedal when you need to play passages that require extreme pianissimo.

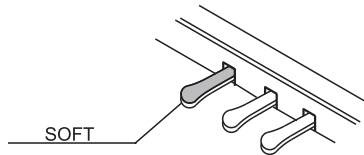

Playing Demo Songs

There are 8 demo songs for you to play individually. Here's how to select and play the demo songs.

■ Listen to Demo Songs

Press the [DEMO] button to enter Demo Mode.

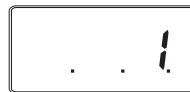
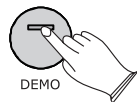

The display will show “ . . 1 ,” and the button will flash, then the demo songs will play in sequence. You can use the [+ / YES] / [- / NO] buttons to select the song you want to play.

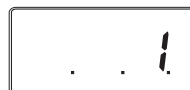
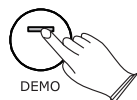

In this mode, you also can use the direct-selecting voice button to select the desired demo song.

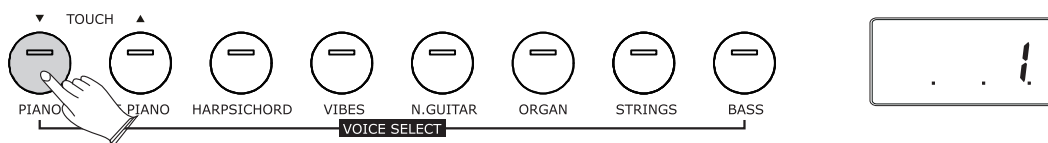

Press the [DEMO] button again to stop playing.

[+ / YES] & [- / NO]

Parameter adjusting buttons.

The Connector Box

Headphones

This piano is equipped with two sets of standard stereo headphone jacks to accommodate private practice or late-night playing. The internal speaker system is automatically shut off when a pair of headphones is plugged into the 1. Headphone jack.

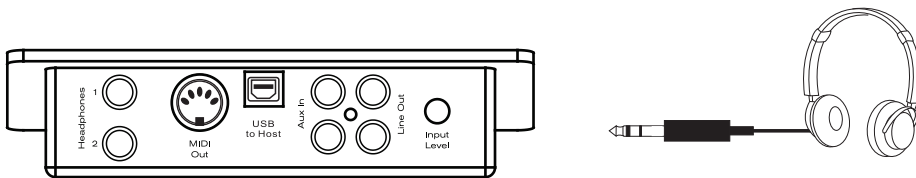

MIDI Out

MIDI (Musical Instrument Digital Interface) is a world-standard communication interface which allows electronic musical instruments to communicate with each other, by sending and receiving compatible notes, program changes and other types of MIDI data. You should only plug the MIDI out in to another device featuring a MIDI input.



NOTE

The MIDI OUT jack transmits MIDI data to another MIDI device.

Line Out

The piano's stereo RCA line output can be used to deliver the output of the piano to a keyboard amplifier, stereo sound system, mixing console or tape recorder. The piano's internal sound system will remain on unless headphones are plugged in to the 1. Headphone jack.

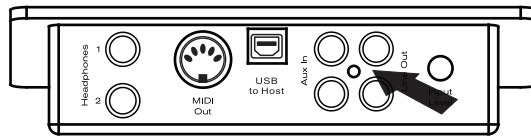

Using USB-MIDI/USB Audio

This product allows the transfer of MIDI information over USB to a laptop, tablet or smartphone. As complicated as this might sound, it's actually pretty straight forward. This piano is USB Class Compliant; therefore there is no need to install a driver to enable it to work with a computer. Simply just plug it in and the computer's operating system will do the rest. The piano will work with all standard MIDI based computer software.

USB AUDIO interface is a digital audio interface. By USB cable, you can digitally transfer intact audio signals from a Laptop, Tablet or Smartphone to this instrument, and enjoy it on this instrument or use it for accompany when you play this instrument; likewise, you can transfer intact audio signals of the instrument to Laptop, Tablet or Smartphone to record and edit music.

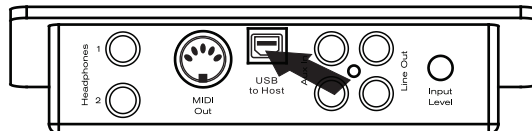

Aux In

The Aux In stereo RCA connectors allow you to play an external sound source (such as a Laptop, Tablet or Smartphone output) through the piano's built-in speakers or headphone outputs.

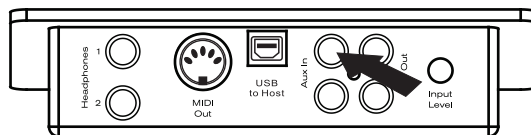

The Aux In signal level can be adjusted using the Input Level knob.

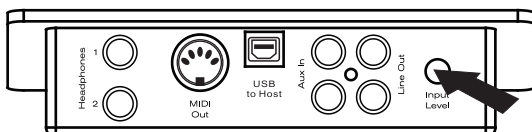

Voice/Effect

This piano has 8 instrument voices and a variation of each voice pattern to choose from. See page 27 for a complete list of all voices.

Selecting a Voice

Select the desired voice by pressing the appropriate VOICE button.

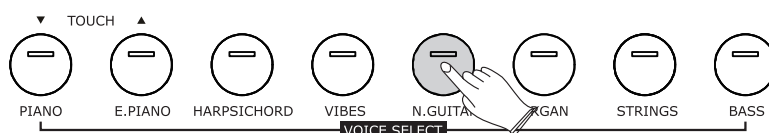

The digital piano has 8 direct-selecting voice buttons.

When pressing a voice button, the assigned voice number is shown on the display and the button will light.

You can change the instrument voice by pressing one of the other instrument voice buttons.

Layer Button

In Layer mode two voices may be played simultaneously, each at selected volumes. Press the [LAYER] button and when the indicator is flashing press a voice button to select the second voice.

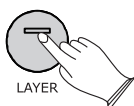

If you do not choose the layer voice within 5 seconds after entering the Layer mode, it will quit this menu automatically.

If the Layer indicator is not flashing, then pressing a voice select button will change the primary voice.

To turn off layer mode: press the [LAYER] button again.

Split Button

Press the [SPLIT] button to activate split mode, your keyboard will be split into two sections that play different voices on the left and right sides of the keyboard.

To activate Split mode: press the [SPLIT] button, then when the Split indicator is flashing press a voice select button to select the left voice.

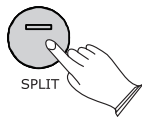

If you do not choose the left voice within 5 seconds after entering the split mode, it will quit this menu automatically.

When the Split indicator is not flashing, then pressing a voice select button will change the right voice.

To turn off split mode: press the [SPLIT] button again.

Reverb

The [REVERB] button selects a number of digital reverb effects that you can use for extra depth and expressive power.

Pressing the [REVERB] button will turn on or turn off the reverb effect.

The default reverb type is “room 3” .

When the reverb mode is turned on, you can use the [+ / YES] and [- / NO] buttons to select reverb type.



The reverb types in the list below can be selected from the reverb display.

00	01	02	03	04	05	06	07	08
Off	Hall1	Hall2	Room1	Room2	Room3	Stage 1	Stage2	Plate

To change the reverb level: see page 16

Chorus

Shimmering, broadening effect that is added to your selected instrument voice.

Press the [CHORUS] button can turn on or turn off the chorus effect.(Default:00)

When the chorus mode is turned on, you can press the [+ /YES] and [- /NO] buttons to select chorus type.



The chorus types in the list below can be selected from the chorus display.

00	01	02	03	04	05	06	07	08
off	Chorus1	Chorus2	Chorus3	Feedback	Flanger1	ShortDelay	ShortDe- layFb	Flanger2

To change the Chorus Level see page 17.

DUET

Press the [DUET] button to select DUET mode. In this mode, the keyboard will be split into two playing areas.

Right: from C#3 to C7

Left: from A-1 to C3

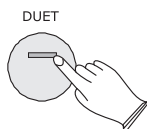

This will be very helpful when the instrument is used by two players at the same time as they will be able to play the same piano sound in the same octave.

Press [DUET] button again to exit the DUET mode.

While the DUET feature is selected using the optional 3 lever pedal, the pedals automatically switch in a different configuration where there are 2 Sustain pedals, one for the left and one for the right part of the keyboard.

Metronome

Metronome is a convenient feature for practice, and it provides a solid rhythmic guide when recording.

Press the [METRONOME] button to turn the metronome off or on.

● Time signature

While holding down the [METRONOME] button use the [+ / YES] and [- / NO] buttons to change the time signature of the metronome .

Time signatures: 2/2, 1/4, 2/4, 3/4, 4/4, 5/4, 6/4, 3/8, 6/8, 7/8, 9/8, 12/8.

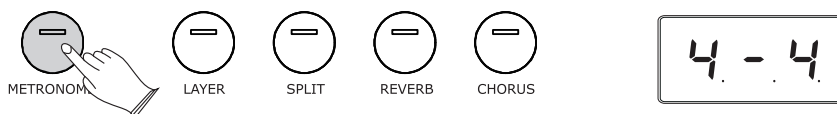

● Adjusting the Metronome Tempo

Use the [+ / YES] / [- / NO] button to change the tempo value range from 20 to 280 BPM (beats per minute).



Touch

The touch function provides six different types of keyboard touch sensitivity that you can try to see which is the best for your playing style: S-Low, S-Normal, S-High, L-Low, L-Normal, L-High. (Default: 02 S-Normal).

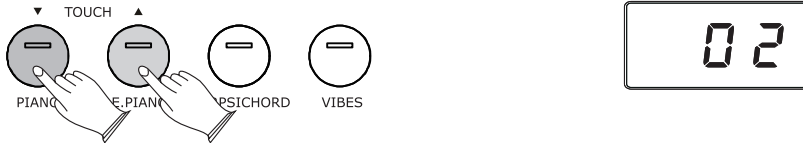

You can press the [TOUCH ◀/▶] button to change the touch sensitivity type. You can use the [+ /YES] and [- /NO] buttons or [TOUCH ◀/▶] buttons to select the touch type.

Range:00-06. (Default: 02)

Set Up

Press the [SET UP] button repeatedly to select the function, see the table below:

Function	LCD Display	Range	Default
Main Voice Volume	F01	00-127	127
Split Voice Volume	F02	00-127	127
Layer Voice Volume	F03	00-127	65
Metronome Voice Volume	F04	00-127	100
Reverb Type	F05	00-08	05
Reverb Level	F06	00-63	18
Chorus Type	F07	00-08	00
Chorus Level	F08	00-63	18
Tune	F09	-64-63	00
Transpose	F10	-12-12	00
Local	F11	On/Off	On
EQ Bass	F12	-06-06	00
EQ Treble	F13	-06-06	00
Song Grading	F14	On/Off	On
Reset	F15		

● Main Voice Volume

In this function you can set the Main Voice Volume.

Press the [SETUP] button repeatedly to select “F01”, then press the [+ / Yes] button to confirm the selection, then use the [+ / Yes] and [- / No] buttons increase or decrease the value. Range: 00 - 127. (Default: 127)

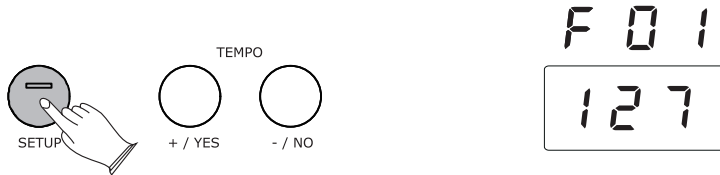

● Split Voice Volume

In this function you can set the Split Voice Volume.

Press the [SETUP] button repeatedly to select “F02”, then press the [+ / Yes] button to confirm the selection, then use the [+ / Yes] and [- / No] buttons increase or decrease the value. Range: 00 - 127. (Default: 127)

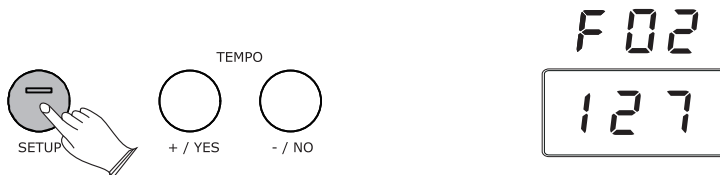

● Dual Voice Volume

In this function you can set the Dual Voice Volume.

Press the [SETUP] button repeatedly to select “F03”, then press the [+ / Yes] button to confirm the selection, then use the [+ / Yes] and [- / No] buttons increase or decrease the value. Range: 00 - 127. (Default: 65)

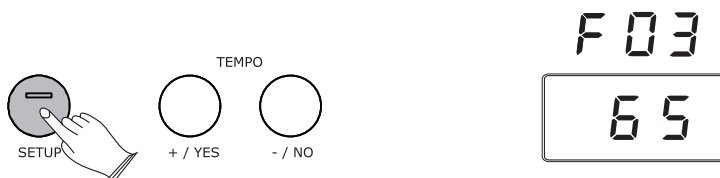

● Metronome Volume

In this function you can set the Metronome Volume.

Press the [SETUP] button repeatedly to select “F04” , then press the [+ /Yes] button to confirm the selection, then use the [+ /Yes] and [- /No] buttons increase or decrease the value. Range: 00 - 127. (Default:100)

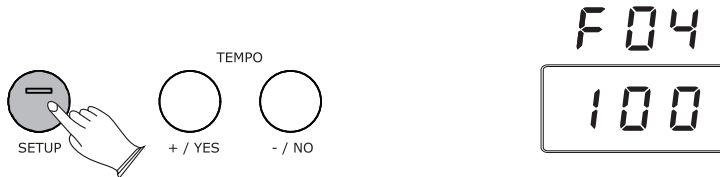

● Reverb Type

Press the [SETUP] button repeatedly to select F05 , then press the [+ /Yes] button to confirm the selection, then use the [+ /Yes] and [- /No] buttons to select the desired Reverb Type. Range: 00 - 08. (Default: 05)

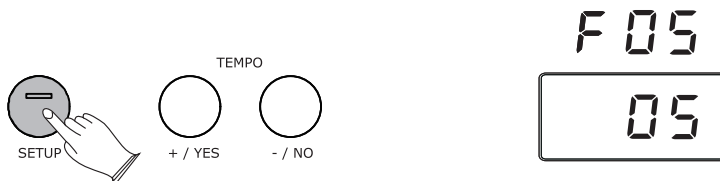

No reverb effect is produced when you select the reverb type “00” .

● Reverb Level

This function allows you to adjust the reverb depth for the voice section.

Press the [SETUP] button repeatedly to select F06 , then press the [+ /Yes] button to confirm the selection, then use the [+ /Yes] and [- /No] buttons to adjust the value. Range: 00 - 63. (Default: 18)

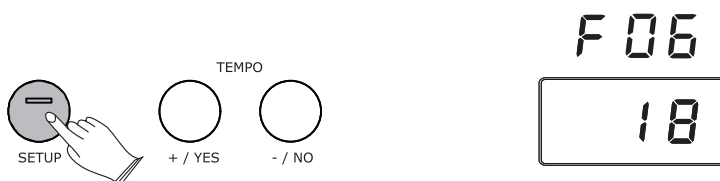

● Chorus Type

Press the [SETUP] button repeatedly to select F07 , then press the [+ /Yes] button to confirm the selection, then use the [+ /Yes] and [- /No] buttons to select the desired Chorus Type. Range: 00 - 08. (Default:00)

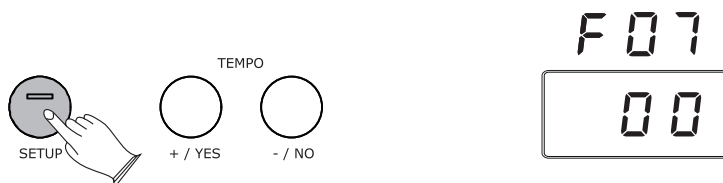

No chorus is produced when you select the chorus type “00” .

● Chorus Level

This function allows you to adjust the chorus depth for the voice section.

Press the [SETUP] button repeatedly to select F08 , then press the [+ /Yes] button to confirm the selection, then use the [+ /Yes] and [- /No] buttons to adjust the value. Range: 00 - 63. (Default:18)

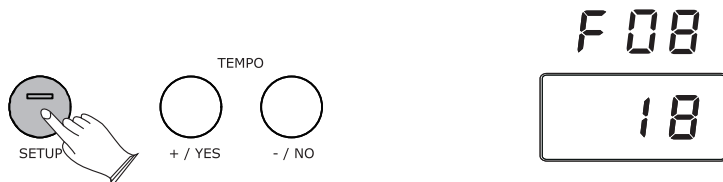

● Tune

This function makes it possible to raise or lower the pitch of your piano.

Press the [SETUP] button repeatedly to select F09 , then press the [+ /Yes] button to confirm the selection, then use the [+ /Yes] and [- /No] buttons to adjust the value. Range: -64 - 63. (Default:00)

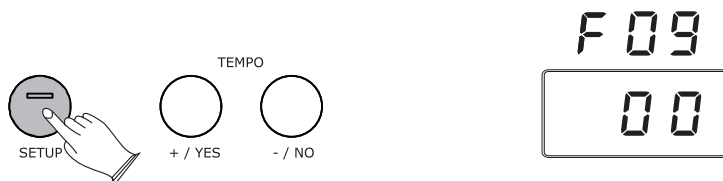

● Transpose

The Transpose function allows you to change the pitch of the piano in semitone steps, up to a maximum setting of 12 semitones (one octave).

Press the [SETUP] button repeatedly to select F10 , then press the [+ / Yes] button to confirm the selection, then use the [+ / Yes] and [- / No] buttons to adjust the value. Range: -12 - 12. (Default: 00)

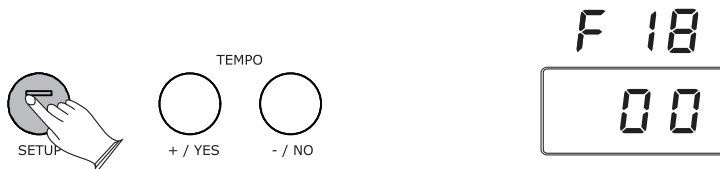

● Local

Using this function, you can turn off the keyboard's internal sound generator, while still sending MIDI data.

Press the [SETUP] button repeatedly to select F11 , then press the [+ / Yes] button to confirm the selection, then use the [+ / Yes] and [- / No] buttons to turn the function on or off. (Default: 0n)

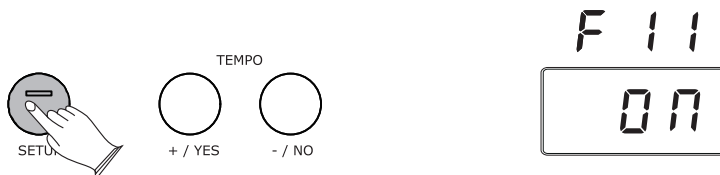

Local on----- Normal operation. Keyboard and Controllers are sent to the Sound Engine. Keyboard plays normally.

Local off----- There will be no sound produced by the keyboards own tone generation system. MIDI function will continue to work as usual.

● EQ Bass

This function allows you to set the EQ Bass for the voice.

Press the [SETUP] button repeatedly to select F12 , then press the [+ /Yes] button to confirm the selection, then use the [+ /Yes] and [- /No] buttons to adjust the value. Range: -06 - 06. (Default: 00)

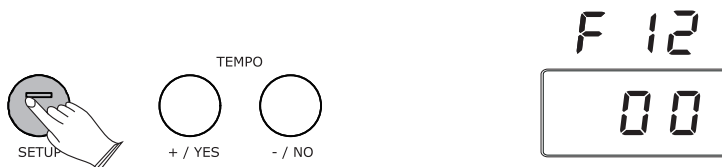

● EQ Treble

This function allows you to set the EQ Treble for the voice.

Press the [SETUP] button repeatedly to select F13 , then press the [+ /Yes] button to confirm the selection, then use the [+ /Yes] and [- /No] buttons to adjust the value. Range: -06 - 06. (Default: 00)

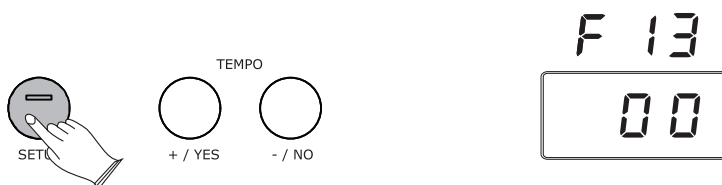

● Song Grading

This function is in the song learning mode, when playing songs, it will automatically score based on your performance.

Press the [SETUP] button repeatedly to select F14 , then press the [+ /Yes] button to confirm the selection, then use the [+ /Yes] and [- /No] buttons to turn the function on or off. (Default: On)

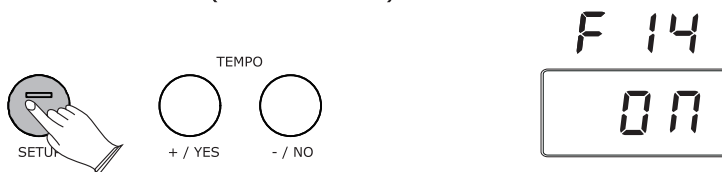

● Reset

Press the [SETUP] button repeatedly to select F15, then press the [+ / Yes] button to confirm and then the piano will reset.



Song Recording

The recording function lets you record your performances using up to two independent tracks. The recorded data will not be lost when you turn off the piano.

Start Recording

Hold down the [RECORD] button, and then press [TRACK-1] or [TRACK-2] button to enter recording mode, the [RECORD] button indicator will light up, and [TRACK-1] or [TRACK-2] button indicator will flash. The recording starts as soon as you start playing the keyboard.



Stop Recording

Press the [RECORD] button again to stop recording.



NOTE

If the other track has data recorded, it will play when recording.
You can mute the other track by pressing its track button.

Listen to Your Recording

To play your recorded song from the beginning, simply press the [PLAY/STOP] button. Playback stops when the [PLAY/STOP] button is pressed again.

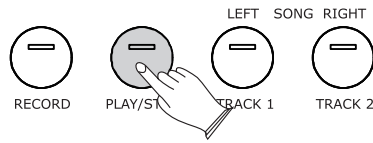

Track Clear

Hold down the [RECORD] button and then press [PLAY/STOP] button to clear all recorded data.

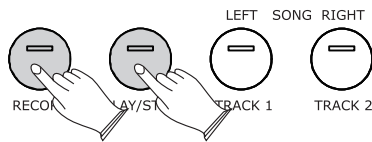

Learning Function

There are 55 songs built into this Piano for your musical enjoyment. These songs have separate left and right-hand parts that can be turned on and off as required so you can practice the corresponding part on the piano.

Selecting A Song

Turn on the song mode by pressing both the [LEFT] and [RIGHT] buttons simultaneously. The [PLAY/STOP] button will begin to flash. The song number will appear on the LCD display.

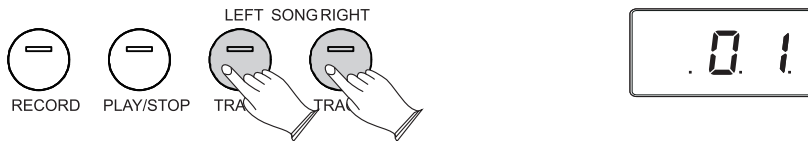

Use the [/NO] / [+/YES] buttons to select a song. Press the [PLAY/STOP] button to start the song.

Listening To The Entire Song

- 1). With the play along song mode engaged, press the [PLAY/STOP] button to hear both hand parts playing the entire song.
- 2). Press the [PLAY/STOP] button again to stop. Otherwise, playback will stop automatically at the end of the song.



Practicing The Right Hand Of The Selected Song

1). Press the [RIGHT] button to mute the right hand part of the song.

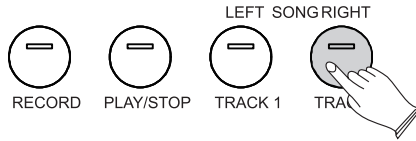

2). Press the [PLAY/STOP] button to start the song without the right hand part.

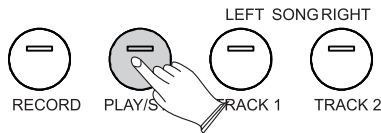

3). Play the right-hand part of your selected song and simultaneously you will hear the left-hand part play.

4). Press the [PLAY/STOP] button again to stop. Otherwise, playback will stop automatically at the end of the song.

Practicing The Left Hand Of The Selected Song

Follow steps 1-4 listed above, substituting the [LEFT] button whenever the [RIGHT] button is mentioned. You will hear the right-hand part of your selected song. Play the left-hand part of your selected song while the right-hand part plays.

Turn off the Learning Function

Press the both [LEFT] and [RIGHT] buttons again to turn off the learning mode.

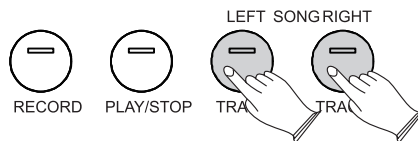

NOTE

If the Song Grading is turned on, after you finish learning one song, your piano may automatically score 0~100 on your performance.

MIDI Function

If you are an advanced MIDI user, this section will help you to access the MIDI controller capabilities of the piano. If you already know that you need this specialized functionality, then this section is for you. However, this information is not necessary in order to enjoy playing the piano.

MIDI, or Musical Instrument Digital Interface, is the way most electronic keyboards communicate with computers and with each other. Through a series of MIDI messages a computer or keyboard can tell an instrument what note to play, how loud to play it, when to stop playing it, and a host of other information.

The piano can send MIDI information to a computer or another MIDI-capable instrument, via its MIDI or USB output. This enables the piano to act as a controller keyboard for another instrument, MIDI sequencer or MIDI enabled Digital Audio Workstation program.

Local On/Off

Turning the Local On/Off function to Off will disconnect the keyboard from the internal sound engine of the piano. This means you can use the piano as a MIDI controller to control other MIDI devices (or virtual instrument software running on your computer) without playing the internal sounds of the piano.

You may also find other occasions (such as when you are using MIDI sequencing software on your computer) where it is useful to turn Local off.

Turn Local On/Off to Off

Please refer to [SETUP] function, see page 18.

Appendix

MIDI Implementation Chart

Function		Transmitted	Recognized	Remarks
Basic Channel	Default	1-16	1-16	
	Changed	1-16	1-16	
Mode	Default	Mode 3	Mode 3	
	Messages	O *****	X X	
	Altered		X	
Note Number	True voice	0~127 *****	0~127	
Velocity	ON	O	O	
Note	OFF	O	O	
After Touch	Key's	X	X	
Touch	Touch Channel	X	X	
Pitch Bend		X	X	
Control Change		0-127	0,1,5,6,7,10,11, 32,64,65,66,67, 80,81,91,93,100, 101,121	
Program Change	True #	0-127 *****	0-7	*8 sounds only PGM=0-7
System Exclusive		O*	O*	*The controller will recognize and respond to GM Device inquiries. Master Tune supported. Master Volume supported.
System Common	Song Position Pointer	X	X	
	Song Select	X	X	
	Tune Request	X	X	
System Real Time	Clock	X	X	
	Commands	X	X	
Aux Messages	All Sounds Off*	O	O	
	Reset All Controllers	O	O	
	Local ON/OFF*	O	O	
	ALL Notes OFF	O	O	
	Active Sensing	X	O	
	System Reset	X	O	
Notes				

Mode1:OMNI ON,POLY Mode2:OMNI ON,MONO O: Yes
 Mode3:OMNI OFF,POLY Mode4:OMNI OFF,MONO X: NO

Voice List

NO.	Voice Name
01	PIANO
02	E.PIANO
03	HARPSICHORD
04	VIBES
05	N.GUITAR
06	ORGAN
07	STRINGS
08	BASS

Factory Reset

Press the [SETUP] button repeatedly to select “F15” , then use the [+ /Yes] buttons to confirm and then your piano will be reset.

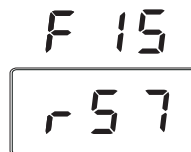
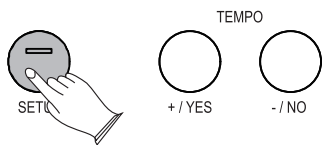

2. Press the [+ /YES] and [- /NO] button and hold down the [STANDBY /ON] button to turn on the piano, then your piano will be set back to factory defaults.

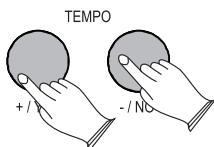

Specifications

Keyboard:

88 Notes Graded Hammer Action

Display:

LED Display

Voice:

8

Polyphony:

64

Voice Control:

Layer, Split, Touch, Duet,
Transpose, Tune

Pedals:

Soft, Sostenuto, Sustain

Effect:

Reverb, Chorus

Demo Song:

8

Midi:

Transmit Settings

Receive Settings

Local Control

USB MIDI

Connectors:

MIDI Out, Pedal, Aux In, Line Out,

Phones1, Phones2, USB to Host,

Input Level

Speaker:

YD166-5-6F80C-R

Dimensions(W × D × H)







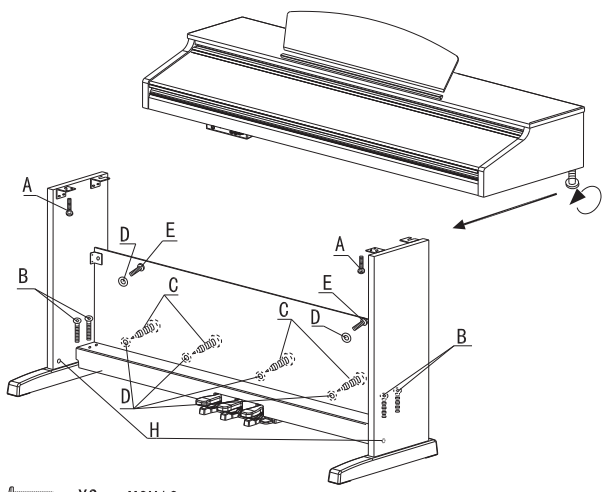
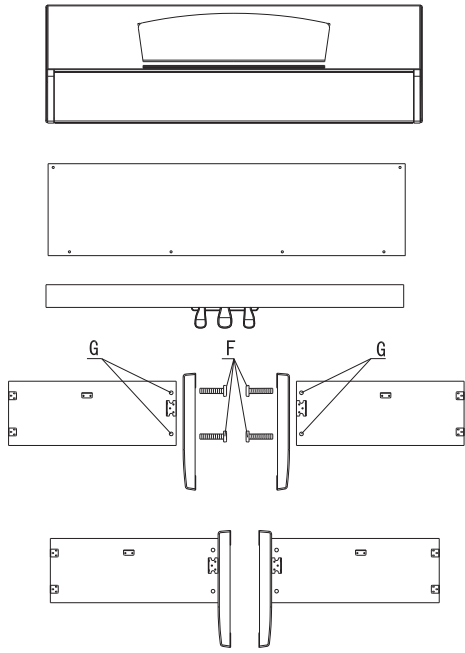

53.5 X 15.1 X 30.5

Weight:

92.6 lbs

Assembly Instructions



- A:  X2 M6X16
- B:  X4 M6X20
- C:  X4 ST3. 9X16
- D:  X6 D=4
- E:  X2 M4X12
- F:  X6 M6X55
- G:  X4
- H:  X4

FCC STATEMENT

1. This device complies with Part 15 of the FCC Rules. Operation is subject to the following two conditions:

- (1) This device may not cause harmful interference.
- (2) This device must accept any interference received, including interference that may cause undesired operation.

2. Changes or modifications not expressly approved by the party responsible for compliance could void the user's authority to operate the equipment.

NOTE: This equipment has been tested and found to comply with the limits for a Class B digital device, pursuant to Part 15 of the FCC Rules. These limits are designed to provide reasonable protection against harmful interference in a residential installation. This equipment generates uses and can radiate radio frequency energy and, if not installed and used in accordance with the instructions, may cause harmful interference to radio communications. However, there is no guarantee that interference will not occur in a particular installation. If this equipment does cause harmful interference to radio or television reception, which can be determined by turning the equipment off and on, the user is encouraged to try to correct the interference by one or more of the following measures:

Reorient or relocate the receiving antenna.

Increase the separation between the equipment and receiver.

Connect the equipment into an outlet on a circuit different from that to which the receiver is connected.

Consult the dealer or an experienced radio/TV technician for help.



Virgin Musical Instrument Company INC

P O Box 2908

La Mesa, CA 91943

PH: 888-998-9848

E-mail: info@virginmusicalinstruments.com

Virginmusicalinstrumentscompany.com